

Installation instructions

Original language: German

Unloader valve ST-265

Product code: all variants



The choice of perfection

Vers. March 23

www.rm-suttner.com

Technical Data

Maximum permissible pressure	350 bar / 35 MPa
Minimum pressure	2 bar / 0.2 MPa
Maximum flow rate	50.0l/min / 13gpm
Water temperature permanently	max. 80°C
Ambient temperature	max. 60°C
Inlet	G3/8 IG
Outlet	G3/8 IG
Bypass	G3/8 IG
Max. solid material size	50µm
pH water	6.5-8.0
Conductivity water [µS/cm]	max. 2000 at 20°C

Abbreviations and symbols	
FT; MT	Female thread; male thread
G	Whitworth pipe thread according to DIN ISO 228, ident. BSP= British Standard Pipe

	<p>The user must wear appropriate protective clothing, for example, in the form of gloves, shoes and goggles. The local safety regulations currently in force should always be observed.</p>
	<p>Please read these Operating Instructions carefully before using the equipment! Keep the Operating Instructions in a safe place for future use or for the next user! These Operating Instructions were prepared with great care. However, SUTTNER GmbH can not be held responsible for any possible errors in the Operating Instructions or for any consequences arising thereof!</p>

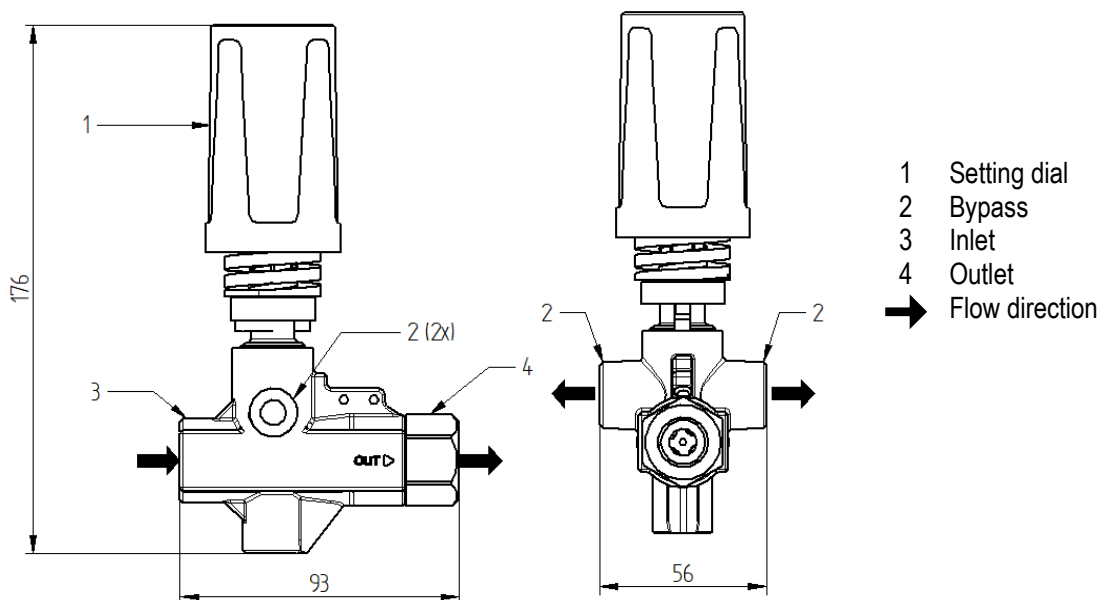

Fig. shows standard variant

Description

Unloader valve

The unloader valve is used to feed the flow rate of a pump back to the pump inlet depending on the operating mode. This prevents the pump from being overloaded and the pressure on the HP hose and spray gun being too high.

The unloader valve is infinitely adjustable. The valve housing is made of forged brass. All components which come into contact with fluid are manufactured from anti-corrosion materials.

Depending on the flow and the force preset on the spring, the unloader valve opens a cross-section to the bypass in order to feed any excess volume back to the pump inlet. If no flow is dispensed, bypass mode of the unloader valve is activated. In this case, the complete flow rate is fed back to the pump inlet.

Unloader valve may not be operated with guns with a frost protection or weep function.

Intended use

The unloader valve is designed for use with water-operated high-pressure systems such as high-pressure cleaners.

All components of the high-pressure system must be compatible with each other. The component with the lowest values (pressure, temperature, etc.) determines the maximal possible load of the high-pressure system. The unloader valve does not replace the safety valve. Only operate the unloader valve together with a safety valve.

The unloader valve is approved only for use with Group II fluids as per EC 1272/2008. This can include, for instance, water and diluted commercially available cleaning or disinfection agents. All safety regulations and rules for high-pressure washers apply as well, e.g. DIN EN 60335-79-2 and DIN EN 1829-1.



Dispensing flammable, explosive, caustic or toxic substances is forbidden!

The unloader valve may not be used with abrasive substances. To avoid damaging the unloader, install a fine filter with a recommended mesh size of 50 µm into the water inlet to the high-pressure pump.

Normative references

- The product is classed as a pressure-maintaining component within the terms of Pressure Equipment Directive 2014/68/EU. Due to the operating parameters, it comes under the scope of Article 4 / Paragraph 3 of this guideline ("good engineering practice") and therefore no Declaration of Conformity and CE marking are allowed!
- The product must not be installed in equipment complying with the Pressure Equipment Directive 2014/68/EU.
- The product is a standard part within the terms of Machinery Directive 2006/42/EC!

Symbols and their meanings





	Hazard! If these instructions are not followed there is a danger of physical injury, danger to life and material damage!
	Please comply with the Operating Instructions! Incorrect operation can lead to severe injury. Read the Operating Instructions before using the equipment.
	Wear safety gloves!
	Wear protective goggles!
	Keep hands away
	Description of imminent hazard and failure to avoid hazard will result death
	Description of hazard and possible resulting injuries or death.
	Description of hazard that could result in minor or moderate injury.

For your safety

This Suttner product is state of the art and complies with generally recognised health and safety regulations. Due to the high pressures and temperatures nonetheless there is the danger of material damage and injury for users and other persons. Please comply with these Operating Instructions at all times and the relevant regulations for liquid jet sprayers.

For details regarding personal protective equipment, refer to the local prevention regulations "Personal protective equipment". Personal protective equipment includes for example overalls, head protection, easy-grip protective gloves and non-slip boots, metatarsal foot protection, respiratory protection, ear protection, eye or face protection.

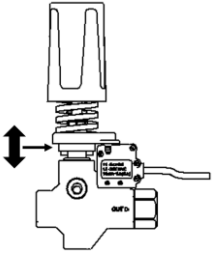
- Cease operation immediately if any leakage or malfunctions occur.
- Malfunctions that may affect safety are to be rectified immediately.
- The unloader may only be used in a technically perfect condition, unmodified in any way, for the purpose intended, in awareness of and compliance with safety requirements and potential hazards and when following these Operating Instructions. Any other or additional use is deemed inappropriate.
- All assembly or installation work must be carried out by authorised specialist personnel.
- Also comply with the operating instructions for equipment and accessories connected to the unloader and with the applicable regulations for cleaning agents.

		<p>Risk of burning or scalding due to hot media! Do not touch anything which is not insulated if you are working with consumables and additives where the temperature exceeds 45°C. Wear protective gloves!</p>
		<p>Risk of injury Lower spring ring is moving up and down, do not touch. By potential risk cover with external housing</p>

Assembly

Delivery scope

The unloader valve is delivered unadjusted.

Unloader valves are high-quality fittings, which must be handled with particular care. The sealing surfaces on the seat and ball are smooth machined to achieve the necessary tightness. The penetration of foreign bodies into the valve must be avoided during assembly, installation and during operation. The tightness of unloader valve can be impaired by hemp, Teflon tape or other sealant as well as by welding beads. Even rough treatment of the finished unloader valve during storage, transport and assembly may cause a unloader valve to leak. If the unloader valves are painted, care must be taken that the sliding parts do not come into contact with paint.

ST-265 unloader valves may be installed vertically or horizontally. The safety function of the valves is tested and confirmed in both installation positions. In order to ensure proper functioning of the unloader valves, they must be installed in such a way that no impermissible static, dynamic or thermal stresses may act on the unloader valve. Ensure the maximum tightening torque of connectors is not exceeded.

- Switch the high-pressure generator (1) off before carrying out assembly work on the high-pressure system.
- Secure the high-pressure generator against being unintentionally switched on.
- Turn the water supply off.
- Release residual pressure by opening spray gun.
- Seal the screw connectors in accordance with your intended use with an appropriate sealant such as Teflon sealing tape or a liquid sealant (see R+M Catalogue, Chapter 06, Adhesives and sealing materials).
- Tighten the screw connections in the high-pressure area to 20 Nm
- Install the unloader valve into the pressure line whilst observing the flow direction
- Create a return line (7)
- Ensure the equipment meets the requirements of the machine guideline after installing the unloader valve in a machine/system!

CAUTION

Make sure that the flow resistance in the return line (7) is not too high. To do so, make sure to use an adequately large line. (Recommendation >DN10)

1. High-pressure generator
2. Pressure gauge
3. Safety valve
4. unloader valve
5. Spray gun
6. Nozzle
7. Return line

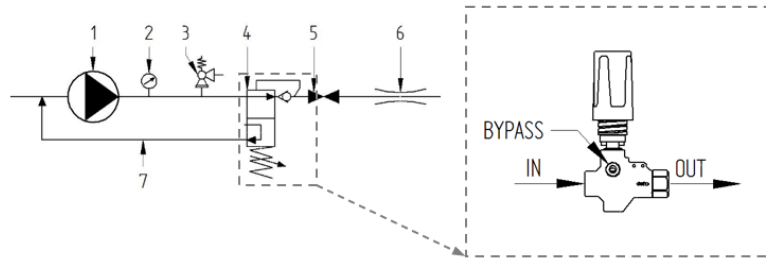

Modification

No modifications of any kind are to be made to the unloader valve!

Setting

The manufacturer of the high-pressure system is responsible for the correct setting and awareness of safety requirements and potential hazards during installation!

CAUTION

If set incorrectly, this can cause permanent overflowing of the flow rate into the return line. This reduces the service life of the unloader valve. When changing to a different nozzle size, the setting must be made again. Ideally, select a nozzle size in the lance so that when working at the desired operating pressure, no water flows through the return line.

- Unscrew the setting dial fully anticlockwise
- Switch on the high-pressure generator (1)
- Open the spray gun (5)
- Screw the setting dial on clockwise until the desired operating pressure is reached or until there is no pressure increase on the pressure gauge.
- To make a fine adjustment, turn the setting dial slowly back again with the spray gun (5) open until the operating pressure falls a few bar below the desired value. Turn the setting dial a quarter turn clockwise with the spray gun (5) open.
- Actuate the spray gun (5) several times and check the operating pressure on the pressure gauge (2)
- The hexagon nut (A) can be used to set the minimum pressure

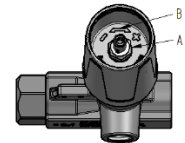

A - Hexagon nut
B - Setting marking

Option switch

If you want to switch off the pump motor during breaks in operation, use the ST-265 with attached switch. The attached switch is a toggle switch for NC/NO signal.

Product variants

unloader valve ST-265			
Product code	20 0265 500	20 0265 550	
Weight	1.00 kg	1.02 kg	
Voltage	-	12-24VDC 12-250VAC	
max. switching current	-	10mA-5A(2A)	
Degree of protection	-	IP65	
Cable (1)	-	1.2 m 3xAWG20	

Maintenance



Assembly, maintenance and repair work may only be carried out by persons trained in maintenance and repair work on high-pressure systems. Use only spare parts approved by Suttner GmbH. Only use high-pressure components (hoses, connectors, etc.) approved for the respective pressure and temperature range.

- Do yearly exterior visual inspection to make sure the unloader valve is safe to use.
- Does the unloader valve leak?
- Does the unloader valve show signs of mechanical damage?
- Does the setting dial turn?
- Does the unloader valve toggle correctly?

After max. 1000 operating hours or a year or if hot water (exceeding 80°C) and chemicals are used after 500 operating hours or 6 months: Check valve parts (O-rings, support rings, hose clips) for damage and if necessary replace completely with a Suttner repair kit.

After max. 3000 operating hours or 3 years or if hot water (exceeding 90°C) and chemicals are used after 1500 operating hours or 18 months: Replace valve parts (O-rings, support rings, hose clips) completely with a Suttner repair kit.

After each use with sticky or impure fluids, rinse the unloader valve with clear water

Disposal



Please dispose of old equipment in an environmentally friendly manner.

Old equipment contains valuable recyclable materials which should be salvaged for recycling. Please therefore dispose of old equipment at suitable collection points.

Manufacturer

Suttner GmbH
Hauptstraße 15-17
33818 Leopoldshöhe
Germany

info@rm-suttner.com
www.rm-suttner.com